

MYN

Map Your Neighborhood

Discussion Guide

**Building &
Strengthening
Disaster Readiness
Among
Neighbors**

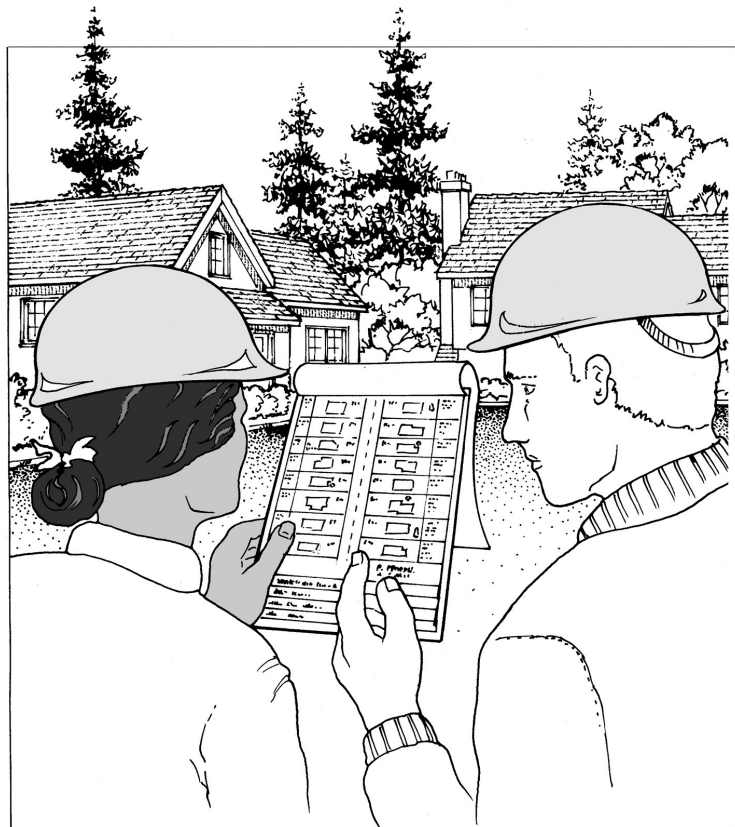

NOTE:
Please read this BEFORE
reading the companion
neighbor Handout.

MYN DISCUSSION GUIDE - INTRODUCTION

MAP YOUR NEIGHBORHOOD - "mine"

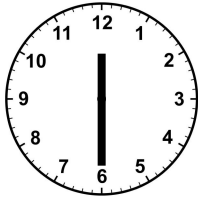

Total Time:
1 1/2 hours

Questions?

call
LuAn K Johnson, PhD
Public Education Program Manager
State of Washington
Emergency Management Division
253-512-7009

email
l.johnson@emd.wa.gov

OBJECTIVES:

During this neighborhood preparedness meeting, you and your neighbors will:

1. learn the *9 Steps* to take *Immediately Following Disaster*
2. identify the skills and equipment each neighbor has that are useful in an effective and timely disaster response
3. create a map of your neighborhood showing the locations of:
 - each natural gas meter and propane tank
 - each neighbor who may need extra help following disasters, including those who are elderly, those with disability, and children who may be home alone for certain hours of the day

DISCUSSION GUIDE:

This Discussion Guide is designed to help you:

1. Have a basic idea of how to guide this neighborhood activity. The **right column** contains one way to cover all the key elements. You are welcome to read this, to paraphrase it, or to use it as keywords to guide your discussion. Time constraints do not allow for the insertion of much additional information. This column will also guide you on the use of visual aids, when to distribute materials, when to ask questions, etc.

Essential **questions** are highlighted by a **Q**.

Answers are highlighted by an **A**.

2. The **left column**, "Discussion Tips & Suggestions," highlights key ideas, reminders, and suggestions to guide your neighborhood discussion.

MYN DISCUSSION GUIDE - PRIOR TO THE MEETING

MAP YOUR NEIGHBORHOOD - "mine"

TIP for Step 2: Asking 1-2 neighbors to help invite your neighborhood will make it easier to personally contact everyone - a personal contact is key in ensuring a good meeting turnout.

A flyer left on the porch is not an effective way to encourage your neighbors to attend this important meeting.

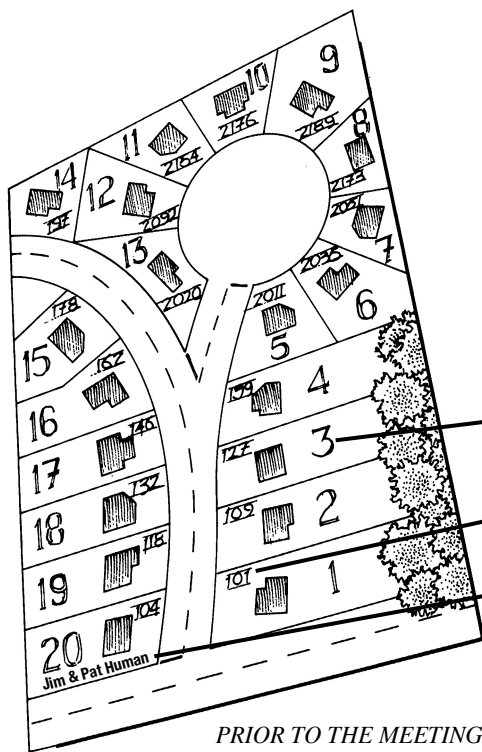

PRIOR TO THE MEETING:

- create a simple drawing of your neighborhood (the free website, earth.google.com may be useful)

DURING THE MEETING:

- neighbors will use your drawing as a model to create their own map in their handout – this will reduce confusion and save valuable meeting time

AT THE CONCLUSION OF THE MEETING, AND **HIGHLY RECOMMENDED:**

- **walk the neighborhood at the conclusion of the meeting** – seeing a meter's actual location creates a visual that is helpful in a disaster response

PRIOR to the Neighborhood Meeting

1. Figure out your neighborhood boundaries. We recommend including 15-25 houses [see Appendix A, page 19].
2. **Personally invite** all neighbors to attend. Also, leave with each neighbor a written reminder of the meeting [see Appendix B, page 20, for a sample reminder].
3. Review this guide so you are familiar with its contents.
4. **Prepare for the meeting by creating a master neighborhood map in advance** (see *Your Neighborhood Map and Contact List* in the neighbor Handout for illustrated instructions):

- a. Draw a map containing streets, blocks, and house lots. This will save valuable time during the meeting if this is prepared in advance. And, it will help make sure you have an accurate 'map' of your neighborhood.
- b. Number the lots sequentially (1,2,3, etc).
- c. Include all house numbers.
- d. Include the names of neighbors if known.

TIP: The easiest way to accomplish this task is to walk your neighborhood, gathering this information.

For the meeting

Have on hand:

- pencils
- erasers

Be ready to show:

- the shoes you keep under your bed

If possible, have these available to show, as well:

- your fire extinguisher [see Appendix F, page 24, for kind and size recommendations]
- your hard hat and leather gloves

MYN DISCUSSION GUIDE

MAP YOUR NEIGHBORHOOD - "mine"

Discussion Tips & Suggestions:

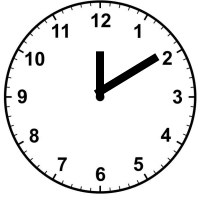

Time for this topic:
10 minutes

TOPIC ONE: Introduction And Welcome

Welcome!

Let's begin this evening by going around the room and introducing ourselves. Tell us who you are and where you live – not your house number – that's not as helpful as telling us what's distinctive about your house. Describe it so that we can connect faces to homes.

Have everyone introduce themselves and describe their house.

Thank you, again, for coming to this meeting on neighborhood disaster preparedness.

In the next 90 minutes, we are going to:

1. learn the *9 Steps* to take *Immediately Following Disaster*
2. identify the skills and equipment each neighbor has that are useful in an effective and timely disaster response
3. create a map of our neighborhood showing the locations of:
 - each natural gas meter and propane tank (oil tanks can rupture and cause leaks, but because the likelihood of this causing a fire is low, we do not need to map their locations)
 - each neighbor who may need extra help following disasters, including those who are elderly, those with disability, and children who may be home alone for certain hours of the day

MYN DISCUSSION GUIDE

MAP YOUR NEIGHBORHOOD - "mine"

Discussion Tips & Suggestions:

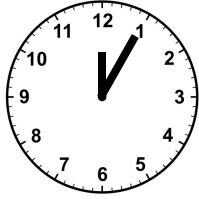

Time for this topic:
5 minutes

IMPORTANT:
*Distribute the MYN Neighbor Handout now,
one for each household in your neighborhood.*

TOPIC TWO: Assumptions & Neighborhood Boundaries

Assumptions about Disasters

As we begin, there are a few assumptions about disaster we need to agree on:

1. A disaster is any event that overwhelms the capacity of 9-1-1 emergency responders. This could be a major earthquake, a volcanic eruption, a tsunami, a major chemical release, or a major winter storm.
2. 9-1-1 emergency responders are fire, medical, police, and utility personnel.
3. If 9-1-1 has so many people needing them that they cannot get to everyone in a timely manner – in other words, they have been overwhelmed –

Q: who, of necessity, become the responders right here in our own neighborhood?

A: *We do, all of us here. Because no one else will be immediately available.*

This meeting will help us be ready for just such events.

Neighborhood Boundaries

For the purposes of responding to disasters, the boundaries of our neighborhood are: _____
[explain who you invited to this meeting]

When disaster occurs, these are the neighbors we will be responding to.

MYN DISCUSSION GUIDE

MAP YOUR NEIGHBORHOOD - "mine"

Discussion Tips & Suggestions:

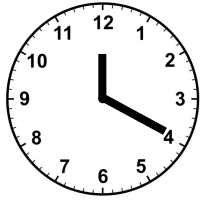

Time for this topic:
20 minutes

While personal preparedness is very important, there is not time to discuss it at this meeting.

If someone should have questions about personal preparedness, have them contact the local office of emergency management noted on the Handout.

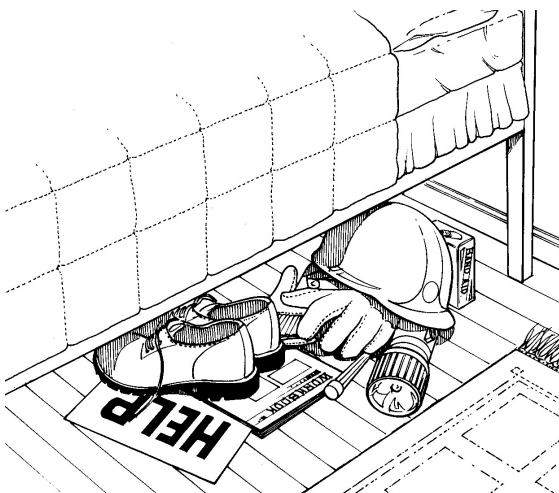

keep sturdy shoes, a hard hat, and leather gloves under the bed – that way, you will always be ready

TOPIC THREE: A – Immediately Following Disaster

Please turn in the Handout to *9 Steps Immediately Following Disaster*.

Q: Where does rational thought go when disaster strikes?

A: Out the window. Studies show people typically do not panic – nor do they necessarily think rationally.

When it is difficult to think our best, these 9 Steps will help us do those things that are necessary and effective in caring first for our individual homes and then our neighborhood.

Step 1 - Take care of home.

Obviously, our first response activities will be in our own homes. The better we have prepared at home the less our own homes will be impacted, and the sooner we will be able to help with the needs of our neighborhood.

Step 2 - Protect your head, hands & feet.

Just like a fire fighter would never show up at a fire without protective clothing, so we should protect ourselves against injury by dressing for safety. This means at a minimum protecting our:

Head - by a hard hat or bicycle helmet (this protects against falling debris, like chimney bricks)

Feet - by sturdy shoes (these protect against the most common injury of all - cut feet)

Hands - by leather gloves (these protect against cuts from broken glass and other debris)

It is recommend that we keep these items under our beds so that we *always* know where they are.

MYN DISCUSSION GUIDE

MAP YOUR NEIGHBORHOOD - "mine"

Discussion Tips & Suggestions:

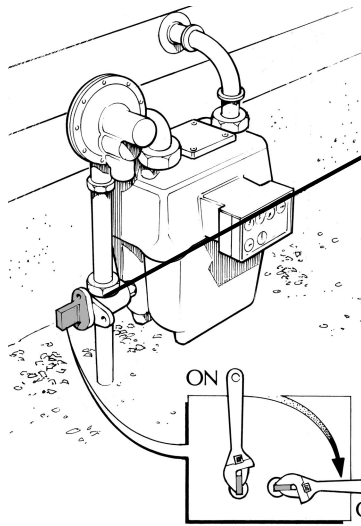

To shut off natural gas:

- find the valve located on the pipe coming up from the ground
- turn the valve 1/4 turn in either direction so the valve crosses the pipe

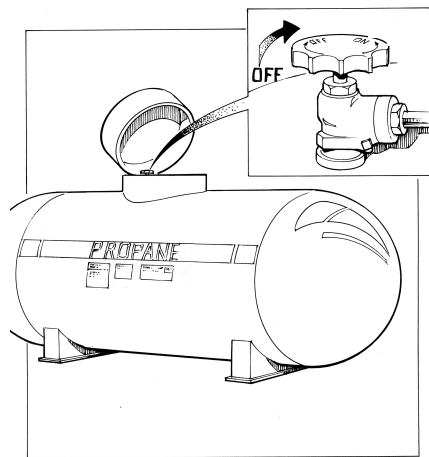

To shut off propane gas:

- find the valve located under the safety cap
- turn the valve to the right until the gas is completely shut off

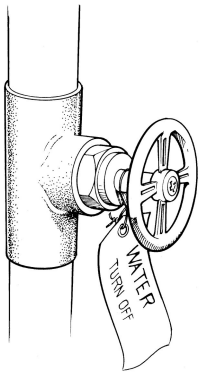

To shut off the water:

- find the master shut-off valve (possible locations include the garage, basement, or near the water heater)
- turn the valve to the right until the water is completely shut off
- it is a good idea to label this valve and to make sure that all household members know where it is located
- NOTE: this is NOT the valve located in a cement box near the street

Step 3 - Shut off the natural gas at your own home.

Shutting off the natural gas [see Appendix C, page 21] and the propane gas [see Appendix D, page 22] eliminates the most common fuel source for many residential fires following disasters, like earthquakes.

To **shut off natural gas** - turn the valve 1/4 turn (90°) in either direction (it's a valve, not a screw) so that the valve crosses the pipe.

It is recommended that everyone have a crescent wrench located right by their meter.

To **shut off propane** - turn the shut-off valve to the right ("righty, tifty") until it closes completely.

Remember:

Shut off the gas if you smell it [like rotten eggs] or hear it hissing as it escapes broken pipes. And, once the gas is shut off, only a crew member from the gas company should turn it back on. They are the only ones qualified to relight your pilot lights and to inspect your pipes for leaks.

Step 4 - Shut off the water at the house main.

Shutting off the water *at the house* will help keep water in the water heater available for drinking, food preparation, and hygiene [see Appendix E, page 23]. If pipes have broken (for example, on the front lawn), gravity may drain the water out of the water heater and toilet tanks. Cracked pipes also may allow contaminants into the water supply.

Shut off the water at the house to protect the water in your water heater, toilet tanks, and house pipes.

NOTE: Shutting off the water at the meter, typically located in a cement box somewhere near the street, requires a special tool and is very difficult to do.

When we return to our homes, let's find this valve and label it. Make sure all in the house know where it is located.

MYN DISCUSSION GUIDE

MAP YOUR NEIGHBORHOOD - "mine"

Discussion Tips & Suggestions:

ABC fire extinguishers can put out these fires:

- A - ordinary combustibles, such as wood, plastic, cloth, and many plastics
- B - flammable liquids, such as gasoline, paints, kitchen grease, and oils
- C - electrical equipment, such as fires in wiring, motors, and appliances

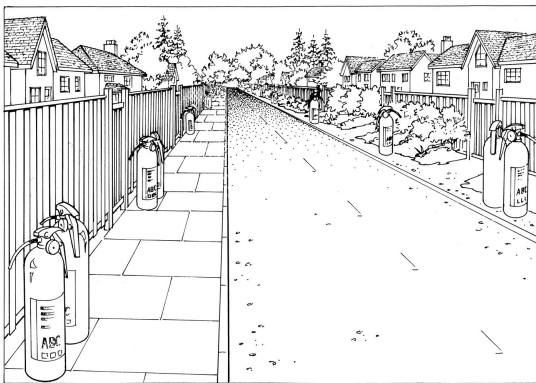
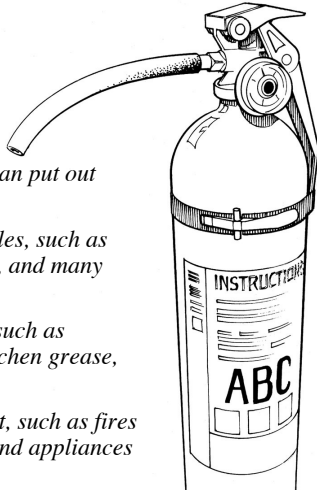

place fire extinguishers so they are easily seen - either on the sidewalk or the street edge

Step 5 - Post OK / Help cards.

Note in the Handout the OK/Help card on the back cover.

Following a disaster, we will want to help our neighbors who are in distress. Please post the OK/Help card on the front door or in a front window so that it is easily seen from the street. This will help us help those in need *first*.

First, we will check on those who display "Help" and those who have not displayed a card. Maybe they are hurt and cannot put the card up.

Later, we will check on all "OK" cards to make sure that everyone is still okay.

Step 6 - Put fire extinguisher on sidewalk or street edge.

Fire can be a big problem during times of disaster because the fire department may not immediately be available.

Placing fire extinguishers outside *on the sidewalk or street edge* makes them visible and available for use in the neighborhood

NOTE: only place them outside *following* disaster.

Remember:

- If the fire is too large, do not attempt to put it out. Quickly evacuate.
- **PASS:**
Pull the pin.
Aim at the base of the fire.
Squeeze the extinguisher handle.
Sweep the fire from side to side.

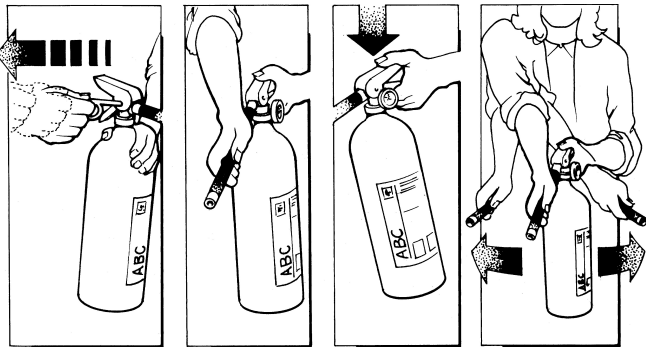

P.

A.

S.

S.

P = pull the pin

A = aim at the base of the fire

S = squeeze the handle

S = sweep from side to side

Discussion Tips & Suggestions:

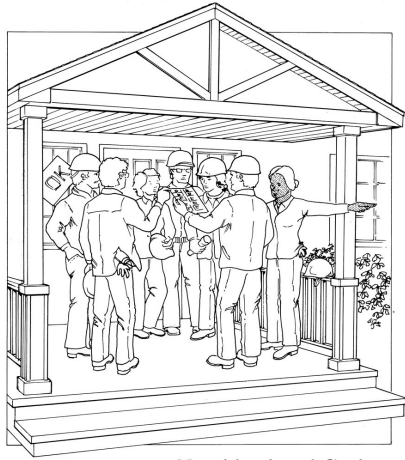

Neighborhood Gathering Site



Neighborhood Care Center

Step 7 - Check in at the Neighborhood Gathering Site.

Please turn in the Handout to *Neighborhood Gathering Site and Care Center*.

The Neighborhood Gathering Site is the place where all of us will gather after we have completed Steps 1-6 of *Immediately Following Disaster* at our own homes.

Q: If we do not take a few minutes to organize - if we all start running around looking for "Help" cards for example - what will we have in the neighborhood?

A. *Chaos*

To help keep chaos to a minimum, we will want to check in at a pre-determined place in the neighborhood. It is best if we select a covered location – someone's garage, a carport, a big porch – in case it is raining. It is also important that it is easily seen. A front porch is better than a back porch. As neighbors begin gathering to this spot, it will remind others to gather there also.

Q: Where should the Neighborhood Gathering Site be?

A: *Determine this site before going on and have everyone write this location in two places in the Handout:*

- *in the top box on Neighborhood Gathering Site and Care Center, AND*
- *in the box for Step #7, Immediately Following Disaster.*

Let's now choose a location for the Neighborhood Care Center. This is a place inside the bounds of our neighborhood where those who are elderly and those with disability can be brought. These folks can be more susceptible to injury. They may also feel frightened and vulnerable. We will not want them to be alone.

Another group we will want to check on are children who may be home alone for certain hours of the day. It can be upsetting to experience disaster without the comforting presence of adults.

Discussion Tips & Suggestions:

This Neighborhood Care Center is the place inside our neighborhood where they can be brought. Most people do not enjoy going to a shelter. It is much more comfortable to be close to home with people you know and who care about your welfare.

Q: Where should the Neighborhood Care Center be?

A: Determine this site before going on and have everyone write this location in the box on the Handout.

TIP: A home with fewer steps is a good choice. It may be difficult for some neighbors to climb many steps.

NOTE: If either the Neighborhood Gathering Site or the Neighborhood Care Center is damaged in the disaster, simply choose another location. MYN teaches us to take advantage of the resources available at the time of the disaster.

IMPORTANT

Looking at the Handout, we are now going to complete the:

- *Neighborhood Skills and Equipment Inventory* and
- *Your Neighborhood Map and Contact List.*

Steps #8 and #9 in the *9 Steps Immediately Following Disaster* will make more sense if we complete these two activities first. We will learn Steps #8 and #9 after that.

MYN DISCUSSION GUIDE

MAP YOUR NEIGHBORHOOD - "mine"

Discussion Tips & Suggestions:

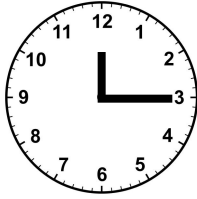

Time for this topic:
15 minutes

All neighbors will want their own lists in case they are the only ones home and available

TOPIC FOUR: IDENTIFYING NEIGHBORHOOD SKILLS & EQUIPMENT USEFUL IN A DISASTER RESPONSE

Please turn in the Handout to *Neighborhood Skills & Equipment Inventory*.

This activity helps us identify the skills and tools we as a neighborhood have that could be very useful during times of disaster. Identifying them in advance will help us save valuable time during a disaster response.

We will complete the Skills list first and the Equipment list second by writing down the names of who can do what.

For example,

Q: Who here has had First Aid training and would be willing to help care for those who have been injured following disaster?

A: Allow the group to respond. Write down the names under *First Aid Skills*.

Q: Who here has experience caring for children and / or elders and would be willing to be at the Neighborhood Care Center to care for them?

A: Allow group to respond. Write those names. Move through the entire list.

We have been given no more than 15 minutes to complete this portion of the meeting, so let's move quickly!

MYN DISCUSSION GUIDE

MAP YOUR NEIGHBORHOOD - "mine"

Discussion Tips & Suggestions:

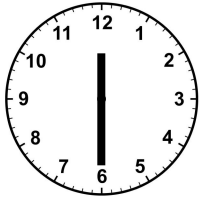

Time for this topic:
30 minutes

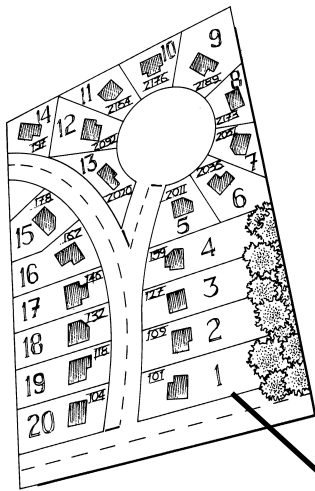

CAUTION: If you do not have house numbers on your pre-made map, allow the group to take time to try to figure out them out, but do not allow this time to go for any more than 5 minutes or this meeting will go much too long.

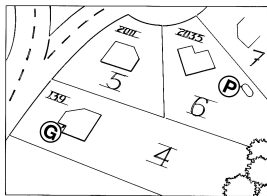

Remember, natural gas meters can be located:

- behind bushes
- behind fences
- under decks
- in front yards
- in side yards
- in back yards
- rarely in plain sight

That is why the exact location of the meter needs to be explained, not just noted that it is "on the south side of the house."

This is also why we encourage you to walk the neighborhood at the conclusion of this meeting – seeing a meter's actual location creates a visual that will be helpful during the stresses of a disaster response.

TOPIC FIVE: NEIGHBORHOOD MAP & CONTACT LIST

We are now going to map our neighborhood and create a neighborhood contact list.

Turn in the Handout to *Guidelines for Neighborhood Mapping*, and *Neighborhood Map and Contact List*. The *Guidelines* are our instructions, and the *Map* is our worksheet. Everyone should fill in the *Map* so that we all have this important information.

Q: Who needs a pencil?

The three drawings on *Guidelines for Neighborhood Mapping* show us exactly what we are going to do.

FIRST: sketch the basic outline of our neighborhood on *Your Neighborhood Map* grid. [IF YOU HAVE PREPARED A MAP, SHOW IT NOW TO MAKE THIS EASIER FOR THE GROUP.] Include the street and rough outline of building lots.

Include the house numbers if they are readily known.

Remember, this map does not have to look pretty. It needs to be useful when disaster strikes.

SECOND: in sequential order, number all the building lots. (See the sample map for what is meant by this.) We need to do this to help us connect each house to the information on the Contact List.

THIRD: mark the *exact location* for each natural gas meter or propane tank. If the disaster occurs at two o'clock in the morning, we will want to know *exactly* who has gas and *exactly* where on the property each meter is located. Leaking gas is a primary source of residential house fire. In this instance, seconds make all the difference – not minutes.

Discussion Tips & Suggestions:

Suggestion:

To save time, you may want to pass around a piece of paper for folks to write their phone # and email address. Ask for a volunteer to distribute this information either by making copies and taking them to each house, or by creating an email distribution list.

Your Neighborhood Contact List (may continue on ne

HOUSE 1 Adult Name(s) Children Name(s) Phone Email Pets(s) and kind(s) Any person with specific needs	HOUSE 6 Adult Name(s) Children Name(s) Phone Email Pets(s) and kind(s) Any person with specific needs	HOUSE 11 Adult Name(s) Children Name(s) Phone Email Pets(s) and kind(s) Any person with specific needs
HOUSE 2 Adult Name(s)	HOUSE 7 Adult Name(s)	HOUSE 12 Adult Name(s)

Please know that all information will be kept confidential and is only for our use as neighbors. Of course, if there is any information a neighbor does not want to share, that is perfectly okay.

FOURTH: This final step is critical. Experience shows time and again that folks who are elderly and those with disability are especially vulnerable during times of disaster. As neighbors, we are their best source of help. Other care takers or loved ones may not be able to get to them for hours or even days.

Creating this Contact List will help us remember to check on everyone, even during the stress of a disaster.

We may not have time to write down everyone's phone and email at this meeting, but we will work to complete our List in the next 48 hours if we don't get it done now.

At this meeting, it is critical that we do two (2) things:

First, match the home you have labeled #1 on the Map with #1 on the Contact List. Who lives in House #1? Write their names on the Contact List.

(If there is time, also add their phone, email, and pets – but do this only if there is plenty of time. It is more important that this meeting take no more than 90 minutes than it is to capture all this information now.)

Make sure everyone in the group writes this down so that all have their own copy.

Match the home you have labeled #2 on the Map with #2 on the Contact List. Who lives in House #2? Write their names on the Contact List. Do the same for entire neighborhood.

Finally – AND MOST IMPORTANT – in the gray boxes, write the **names of those who may need extra help** during disasters. This includes neighbors who are elderly, neighbors with disability, and children who may be home alone. Writing the names here will help us remember to check on these specific neighbors soon after disaster occurs.

Discussion Tips & Suggestions:

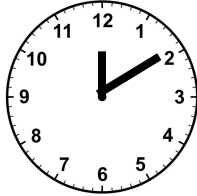

Time for this topic:
10 minutes

TOPIC SIX: REVIEW 9 STEPS IMMEDIATELY FOLLOWING DISASTER & LEARN ITS FINAL TWO STEPS

Let's review what we have accomplished so far, and finish Steps #8 & #9 of *Immediately Following Disaster*.

It's 3:30 a.m. All of a sudden, a major disaster impacts our neighborhood. [Feel free to insert earthquake, tsunami, winter storm, etc. - whatever is relevant to your neighborhood.] For a moment, rational thought flees and you, in this early morning hour, wonder what has just happened and what to do. Then you remember your MYN Handout and grab it. Turn to *9 Steps Immediately Following Disaster*.

Step #1:

First, care for our loved ones. We have done a good job preparing at home, so even though we are a bit shaken up, we are fine.

Step #2:

Protect your head, hands, and feet. We put on sturdy shoes to protect our feet from glass and debris, and a hard hat to protect our head from possible falling objects like bricks, especially once we go outside. We put on leather gloves so that should we encounter sharp or rough debris, our hands are protected.

Step #3:

We go outside and inspect the gas meter. If we can smell the gas or hear it hissing and escaping from a broken pipe, immediately shut it off.

Step #4:

We then shut off our house water at the main house valve located somewhere in the house (not the valve in the cement box). This allows us to trap the water that is in the water heater and to keep it safe from pollutants that may enter through cracked pipes.

Step #5:

Post the OK / Help card from the back of this Handout on the front door or window. Neighbors will know to come and help if we have Help displayed, or if we have no card up. Perhaps we have been injured and are unable to tape it up.

Discussion Tips & Suggestions:

You can find out your local AM/FM emergency alert radio station and your NOAA Weather Radio channel by calling your local office of emergency management or by checking online.

Review your Contact List for neighbors who are elderly, neighbors who have disability, and children who are home alone for certain hours of the day.

Review your Neighborhood Map for gas meter locations.

Step #6:

Place our fire extinguisher outside on the sidewalk or the street edge. *Make sure these are easily seen.* If someone should yell "Fire, we've got fire" or if we should see smoke, we will be grateful to have a whole street full of extinguishers. If extinguishers are left on porches, neighbors will not take time to look for them. We will grab the extinguishers we can see and get over to that fire while it is small enough to safely extinguish it.

NOTE: Steps 1-6 are completed at our individual homes.

Step #7:

It is now time in our disaster response to come together as a neighborhood. The first thing we will do is gather at our Neighborhood Gathering Site so that we know who is available to help. Sure this takes time. But if these few moments are not spent organizing our neighborhood response, we only have chaos in the neighborhood. We need to know who is available to help.

Q: We will meet at: _____?

A: Review this location.

Step #8:

By coming to our Gathering Site, we will be able to assign groups of neighbors to do four (4) critical tasks. **NOTE: We will always go in teams of at least two neighbors. This is for our safety and protection.**

One team will stay at the Neighborhood Gathering Site and listen for emergency information on either an AM/FM radio or a NOAA Weather Radio.

One team will go and check on all those we have identified who need to be checked on immediately – those listed in the gray boxes on the Neighborhood Contact List.

One team will check all natural gas meters and propane tanks, using the information from our Neighborhood Map. If they can smell gas or hear it escaping from broken pipes, they will shut it off.

Discussion Tips & Suggestions:

One team will go door-to-door checking for all Help cards and homes with no cards. They will coordinate giving the help and assistance that is needed. (They may want to take a first aid kit with them.)

Step #9:

When each team has completed its assignment, it will report back to the Neighborhood Gathering Site and give a report of what they have done. As information is shared, the entire neighborhood will know what has happened and what the response has been. If additional help is required, plans can be devised to respond to those needs.

TO REVIEW:

Q: If someone has a fire, what is our neighborhood response?

A: Grab the extinguishers placed outside on the sidewalk or street edge and get over to the fire while it is still small.

Q: Where will the extinguishers come from?

A: From our homes. They have been placed on the sidewalk or street edge so that they are easily seen.

Q: Who will fight that fire?

A: Everyone - grab the extinguishers and go. With many people helping, we will be able to put out the fire while it is small.

Q: What if the fire is too large?

A: We will let it go - we will not put our safety in jeopardy.

Q: If an elderly person is alone and frightened, what is our response?

A: One Team of neighborhood responders will be going around pretty quickly to check on them.

They will take them to the Neighborhood Care Center located at: [review location].

Some of those assigned to this Team will stay at the Care Center to provide the needed help.

Discussion Tips & Suggestions:

Q: If we smell leaking gas, what do we do?

A: *First, at our own home, we will shut off natural gas by turning the valve one-quarter turn or 90°. Shut off propane gas by turning the valve to the right until it closes.*

Second, as a neighborhood, we will use our Map to quickly check all the gas meters to determine the source of the leak. We will shut off those meters.

We have made excellent progress in preparing our neighborhood for disaster!

WHERE DO WE GO FROM HERE

In about a year, we will meet again to take the next step. We will update our map and contact information to include those who have moved into our neighborhood and those who were not able to meet with us today.

Then, we will go through a realistic disaster scenario to see how the *9-Steps Immediately Following Disasters*, our *Neighborhood Map and Contact List*, and our list of *Neighborhood Skills and Equipment* will help us when disasters strike. This practice will help us develop confidence and competence in responding to disasters when they occur.

Remember, when you get home:

- find your master water shut-off valve and label it
- get a pair of sturdy shoes under everyone's bed
- plan to get a hard hat and leather gloves for everyone and put these under their beds

Thanks for coming.

Appendices

page 19.....A - FAQs about MYN

page 20.....B - meeting reminder

page 21.....C - gas shut-off

page 22.....D - propane shut-off

page 23.....E - water & electricity shut-off

page 24.....F - fire extinguishers safety

page 25.....G - basic search & rescue procedures

Appendix A - FAQ's (Frequently Asked Questions)

Q: *How big should my neighborhood be?*

A: We recommend about 15-25 homes. This is a typical block, corner to corner, both sides of the street. We recommend including "line of sight" homes. When disaster strikes, we tend to respond to those things we can see.

For rural neighborhoods with larger properties, we recommend including as many homes as you feel you can comfortably check on in an hour or two.

Q: *What if I live in an apartment or high-rise building?*

A: Vertical neighborhoods work very well. In this instance, your whole building is your neighborhood.

Q: *What if I live in a condominium complex?*

A: If the complex is larger than 25 homes, consider dividing it into smaller groups.

Q: *Why does the number of houses matter?*

A: Because we are organizing and preparing for disaster, we want to keep in mind the dynamics of an effective response. The most effective response occurs in the first hour following disasters. It is called the "golden 60 minutes" because of its value in saving lives, reducing the severity of injury, and reducing property and environmental damage. If a group is too large, it becomes difficult to complete an effective response in that first hour.

Q: *How do I determine who to invite to my meeting?*

A: Our goal is to be prepared to care for ourselves and for others when fire, medical, police, and utility first responders are inundated with requests for help, severely limiting their ability to get to all who need them in a timely manner. Experience shows that people genuinely want to help each other when these events occur. Imagine a major disaster occurring. Who would you want to help? How far would you naturally extend your reach? That is who you want to include in your group. You also want the size to be manageable, which is why we recommend about 15-25 homes.

Q: *Why do I need to personally invite my neighbors?*

A: Experience is very clear on this one. A personal invitation is what encourages your neighbors to attend. A full house generates lots of enthusiasm and energy. We have included a written reminder to leave with your neighbors to remind them of the date, but to ensure a good turnout, invest the time and extend a personal invitation.

Q: *Doesn't it take a lot of time to personally invite everyone?*

A: Many groups have found it beneficial to have two or three neighbors help with inviting. That way it will not take any one person as long. Remember, the time invested in inviting is typically rewarded with a good turnout at the meeting.

Q: *No one has a house big enough to hold our whole neighborhood - we want to hold the meeting in a school, community building, or church. Is this a good idea?*

A: Experience is very clear on this one, too! The answer is generally no. There is a direct correlation between where the meeting is held and the number of neighbors who will attend. Even if the school is in the neighborhood, it creates 'distance.' To maximize your turnout, hold the meeting in someone's home. If people have to sit on the floor, that's okay! The meeting is dynamic enough that most people don't mind. If you are concerned about not having enough chairs, ask people to bring a chair or a pillow to sit on when you invite them.

Meeting Reminder - “MYN” *Map Your Neighborhood* for disasters

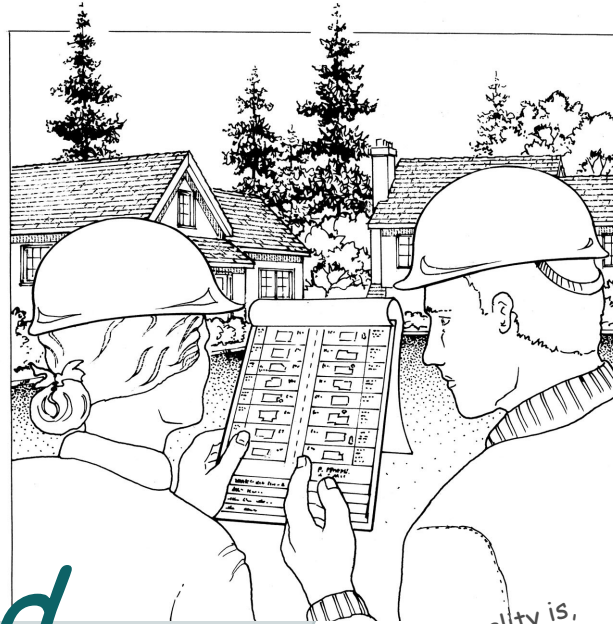

The reality is, neighborhoods may need to respond to fire, injuries, & leaking natural gas during disasters. This meeting will help us know how. Please come.

What is disaster? Disasters, by definition, are events that overwhelm police, fire, and medical 9-1-1 emergency responders.

Why MYN? MYN helps us organize a timely response to disaster when 9-1-1 is unavailable. All of us, working together, can reduce the serious consequences of disaster in our neighborhood.

- What will we do?**
- We will learn a 9-step Response Plan that immediately helps us know what to do – both at home and in the neighborhood – to respond to injuries, leaking natural gas, & people who may be alone and frightened. The process is proven, easy, and fun.
 - We will identify the skills and equipment each neighbor has that are useful in an effective and timely disaster response .
 - We will map our neighborhood natural gas meters and propane tank locations so we can quickly respond to leaking gas and reduce the threat of fire.

BONUS We will all go home with a neighborhood map, contact list, and skills & equipment inventory.

Date

Time

Place

If you have a natural gas meter, please take a few minutes before coming to determine its exact location.

Thanks!

Appendix C - Natural Gas Shut-Off

Natural gas leaks and explosions are responsible for a significant number of fires following any major earthquake. *It is vital that all household members know how to shut off the natural gas.*

Preparing to shut off the natural gas

- Locate the shut-off valve. To shut off the gas, turn the valve 90°, or 1/4 turn, so that it crosses the pipe.
If your valve is rusted open, do **not** put WE-40™ or similar lubricant on it. It may corrode the O-rings that allow the valve to turn.
- Place a **12-inch crescent wrench** at the meter, or attach one to the wall directly behind the meter. This saves time in trying to locate one immediately following disaster.
Adjust it to fit your valve in case it rusts.

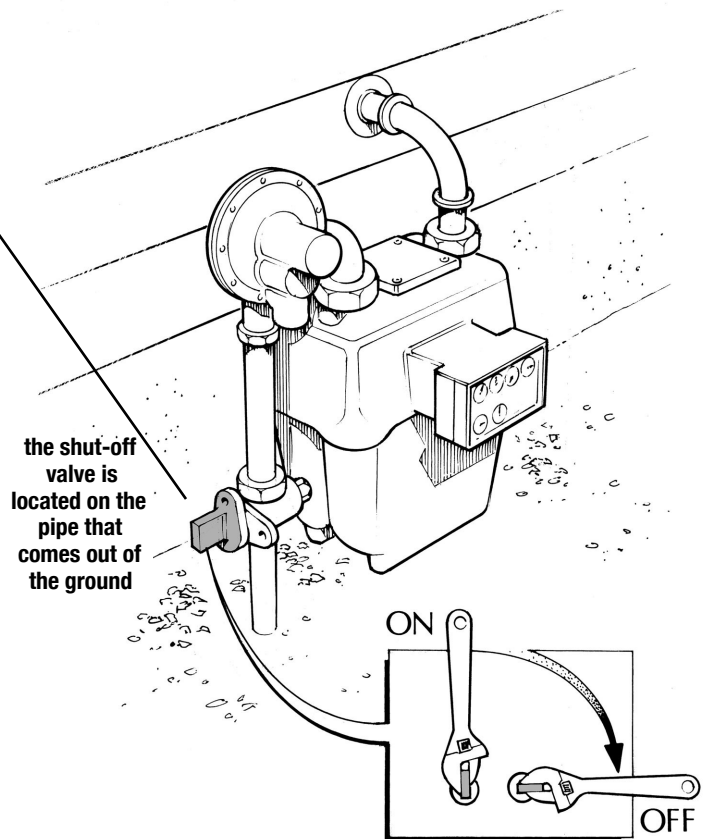
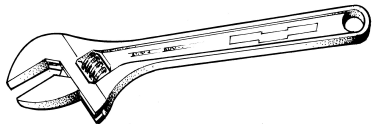

Shutting off gas after an earthquake

- Shut off the gas immediately **only** if you smell the characteristic odor of gas, you hear a hissing sound, and/or you notice the meter dials spinning more rapidly than normal.
- Do not use matches, lighters, open flame appliances, or operate any electrical switches until you are sure no gas leaks exist. Sparks from electrical switches could ignite the gas.
- If you smell natural gas, immediately get everyone out of and away from the house. Open the windows and doors to provide ventilation. Shut off the gas at the meter.

NOTE:

- NEVER turn the gas back on once it has been shut off. If you do, you may create a gas leak in your home.
- Only a certified plumber or crew member from the gas company knows how to safely relight your pilot lights AND how to inspect your system for leaks.

Appendix D - Propane Gas Shut-Off

Propane Safety

- propane vapors are heavier than air and may accumulate in low-lying areas such as basements and ditches or along floors
- propane won't ignite when combined with air unless the source of ignition reaches at least 940°F.
- propane is naturally odorless, but an odor, like rotten eggs, is added so that leaks can be detected

Shutting off propane after a disaster

- the valve to shut off propane looks like a typical water shut-off valve
- to shut off the propane, turn the valve to the right ("righty, tighty") until the valve tightly closes

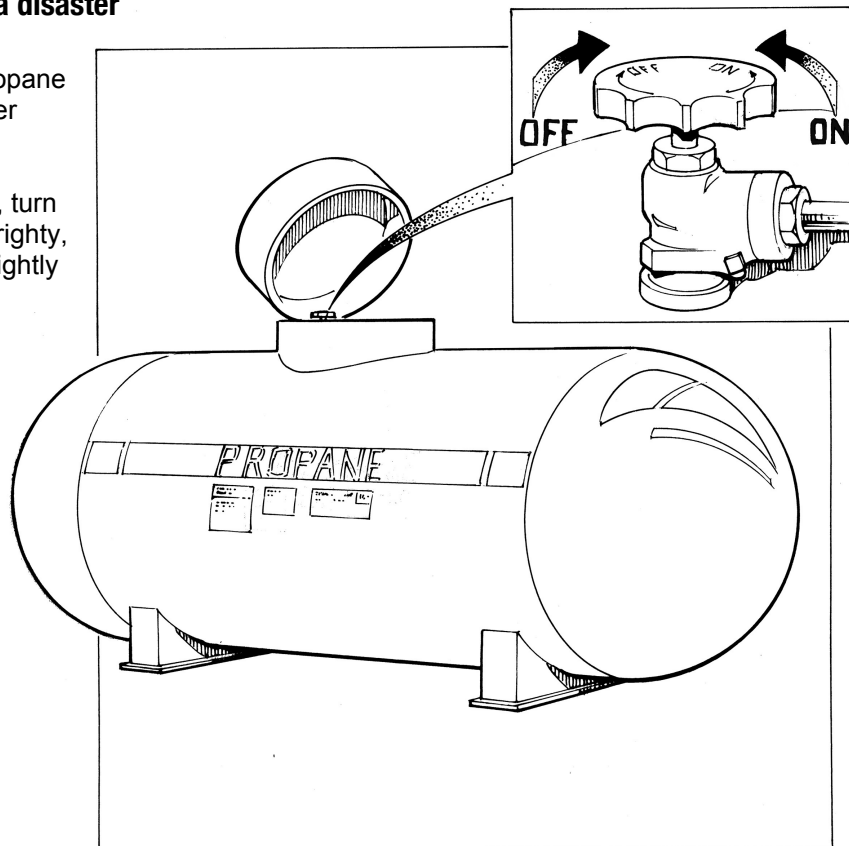

Appendix E - Water & Electricity Shut Off

Water

Water quickly becomes a precious resource following many disasters. It is vital that all household members learn how to shut off the water at the main house valve.

- Cracked lines may pollute the water supply to your house.
- The effects of gravity may drain the water in your hot water and toilet tanks unless you trap the water in your house by shutting off the main house valve (not the street valve in the cement box at the curb – this valve is extremely difficult to turn and requires a special tool).

Preparing to shut off water

- Locate the shut-off valve for the water line that enters your house. Possible locations include the garage, the basement, or near the water heater.

It may look like this:

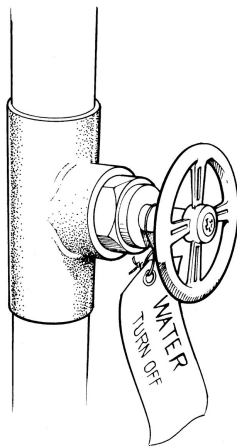

- Make sure this valve can be completely shut off. Your valve may be rusted open, or it may only partially close. Replace it if necessary.
- Label this valve with a tag for easy identification, and make sure all household members know where it is located.

Electricity

Electrical sparks have the potential of igniting natural gas if it is leaking. It is wise to teach all responsible household members where and how to shut off the electricity.

Preparing to shut off electricity

- Locate your electricity circuit box.
- Teach all responsible household members how to shut off the electricity to the entire house.

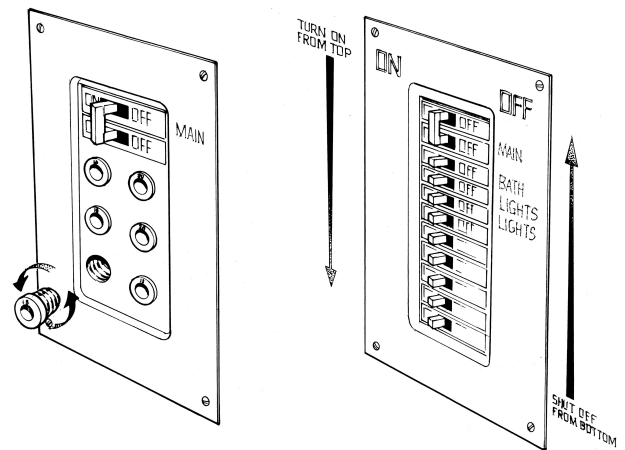

FOR YOUR SAFETY & TO PREVENT ELECTRICAL SHOCK: Always shut off all the individual circuits before shutting off the main circuit breaker.

When turning the electricity back on, first turn on the main breaker. Then, turn on all the individual breakers.

Outside

Stay far away from downed power lines. You cannot tell by looking at them whether they are 'live' or not. NEVER try to move them. NEVER try to hop over them. NEVER walk under a power line that is resting on a tree branch or fallen tree.

It may be a while before official crew members can come and secure downed wires. If so, experts from the power company recommend creating a barrier around the downed lines by *roping them off at least 50 feet in all directions*. This will help prevent neighbors from accidentally coming in contact with them.

Appendix F - Fire Extinguisher Safety

- Locate your fire extinguishers with care. Fire moves quickly – quick access can make all the difference.

- Several smaller extinguishers located throughout the house are better than one large one that may be difficult to quickly get to.

Key places for your extinguishers are:

- the kitchen
- the garage, and
- one on every level if your home has multiple floors.



Recommended Size:

approximately 7 lbs. (this will be printed on the canister)

Using a fire extinguisher

- **VITAL:** Keep an escape route open between you and the *small* fire. If the fire is large or becomes too large, immediately get out of the house.

Close the door on your way out to slow the spread of flames.

- Once you are outside, stay outside. Intense heat and toxic fumes can kill you in seconds.

- **A:B:C extinguishers are recommended:**

"A" fires – ordinary combustibles such as wood, paper, cloth, and many plastics

"B" fires – flammable liquids such as gasoline, paints, kitchen grease, and oils

"C" fires – electrical equipment, such as fires in wiring, motors, and appliances

P.A.S.S. - a proven and effective system for putting out fire

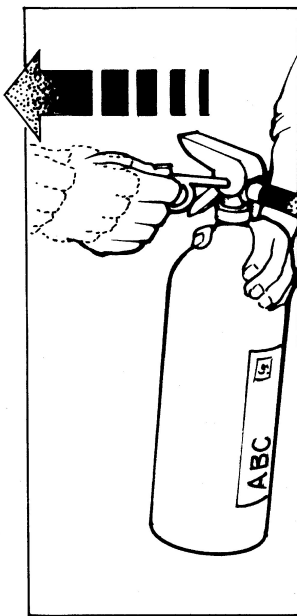

P. Pull the pin.

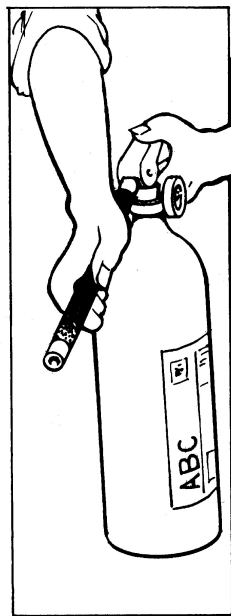

A. Aim at the base of the

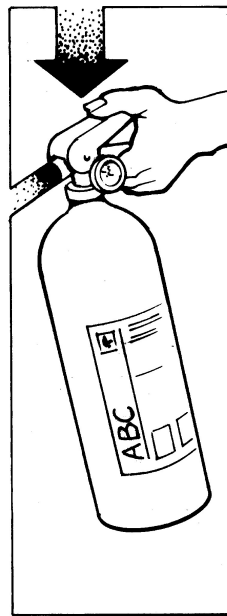

S. Squeeze the handle.



S. Sweep the hose side to side.

Appendix G - Basic Search & Rescue Procedures

1. Dress in long pants, a long-sleeved shirt, and sturdy boots. Leather gloves, a hard hat, and a flashlight are essential. Goggles, a dust mask, and a small first aid kit to take care of your own basic needs are also good ideas.
2. Establish who your partner will be. Never conduct a search and rescue alone.
3. YOUR SAFETY IS MOST IMPORTANT. If the house is significantly damaged and you feel it is unsafe to enter, respect your feelings. Do not go in.
4. Before you enter each home, place 1/2 of a large tape "X" on the front door. This signals to the neighborhood your exact location.
5. Before you enter each home, feel the top and bottom of the door with the back of your hand. If it is hot, do not enter. If it is cool, cautiously open the door.
6. Check the door jamb, and its accompanying wall and ceiling for cracks and splinters. If the house appears unsafe, do not enter.
7. Enter the house low, preferably on your knees. Be alert. Watch for falling objects.
8. While still in the entry way, smell for the odor of natural gas. If you can smell it, open the front and back doors and as many windows as you are able *without going inside* to provide ventilation. Enter the house only when the smell of the gas is gone.
9. While still in the entry way, loudly call out, "Is anyone here?" Listen for a response. If someone answers, ask them to tell you where they are, and what type of help they need. Pause occasionally during the search to listen for cries, moans, or other indicators of someone needing help.
10. Systematically search each room. Do not wander aimlessly. Stay with your partner. Communicate frequently. Pay careful attention to these critical areas: under beds, behind furniture, inside closets, under stairs, and inside tubs or showers.
11. If it is dark, slowly sweep each room with your flashlight. Frequently check the floor and the ceiling of the area you are in for hazards. Protect your own safety.
12. If it is dark, keep in contact with the wall. It is easy to become disoriented after experiencing trauma. Should you become disoriented, following the wall will eventually lead you back to the original entry door.
13. If you find a victim, get several neighbors to help move her/him as quickly as possible to a neighbor's home (NOT to the Neighborhood Care Center – you will not want to add to the trauma some neighbors have already experienced).
14. Upon completion of the search, complete the tape "X" on the door. This signals to the neighborhood that the house has been checked and is okay.

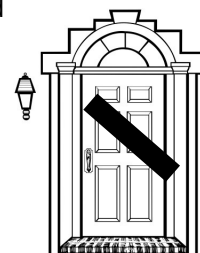

NOTE:
You will need blue painter's tape to do this. Other tapes will leave a very sticky residue.



Remember: There is no golden rule for risking your life to rescue others. If your attempts are obviously beyond your physical capacity or skill, you may lose your life, and you may endanger others coming to your aid. *Sometimes it takes wisdom and courage to wait for help.*